

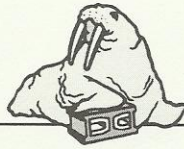

Protection is a concrete idea.



Grout Areas with Masonry Walls Insulated with Korfil Inserts

8 Inch Units

Volume = (234.2 in.³)

1 cu yd = 46,656 in.³

Approx 199 8-inch Blocks with Korfil Inserts can be grouted with 1 cu yd.

10 Inch Units

Volume = (351.3 in.³)

1 cu yd = 46,656 in.³

Approx 132 10-inch Blocks with Korfil Inserts can be grouted with 1 cu yd.

12 Inch Units

Volume = (510.1 in.³)

1 cu yd = 46,656 inches³

Approx 91 12-inch Blocks with Korfil Inserts can be grouted with 1 cu yd.

Paul Grycel 
Director of Engineering
9 May 2014

Concrete Block Insulating Systems
P.O. Box 1000
Freight House Road
West Brookfield, MA 01585-1000

508.867.4241
800.628.8476
Fax: 508.867.5702

www.cbisinc.com
E-mail: korfil@cbisinc.com
Member of NCMA and EPSMA



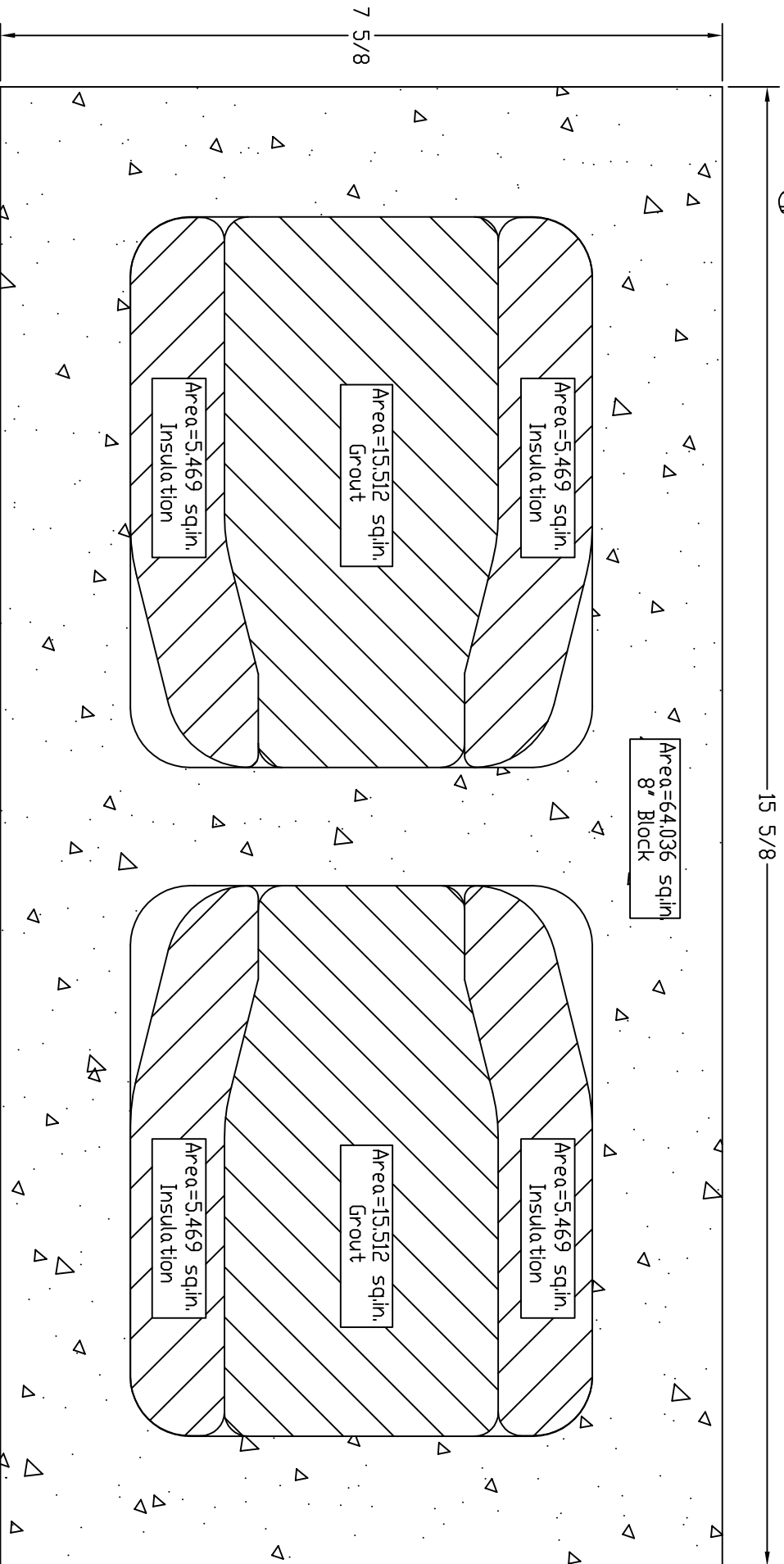
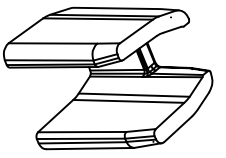

NOTE:

1. 8" Block Dimensions per NCMA Standards
2. View Shown at Half High Level
3. Korfil U-Shape Insulation Shown
4. Upper View Shown (The Void Section At The Center Web Is Where The Hand Hold Area Is Located)

CBIS/KORFIL

P.O. BOX 1000
FREIGHT HOUSE ROAD
WEST BROOKFIELD, MA. 01585
WWW.CBISINC.COM



GRYCEL
5/7/2010

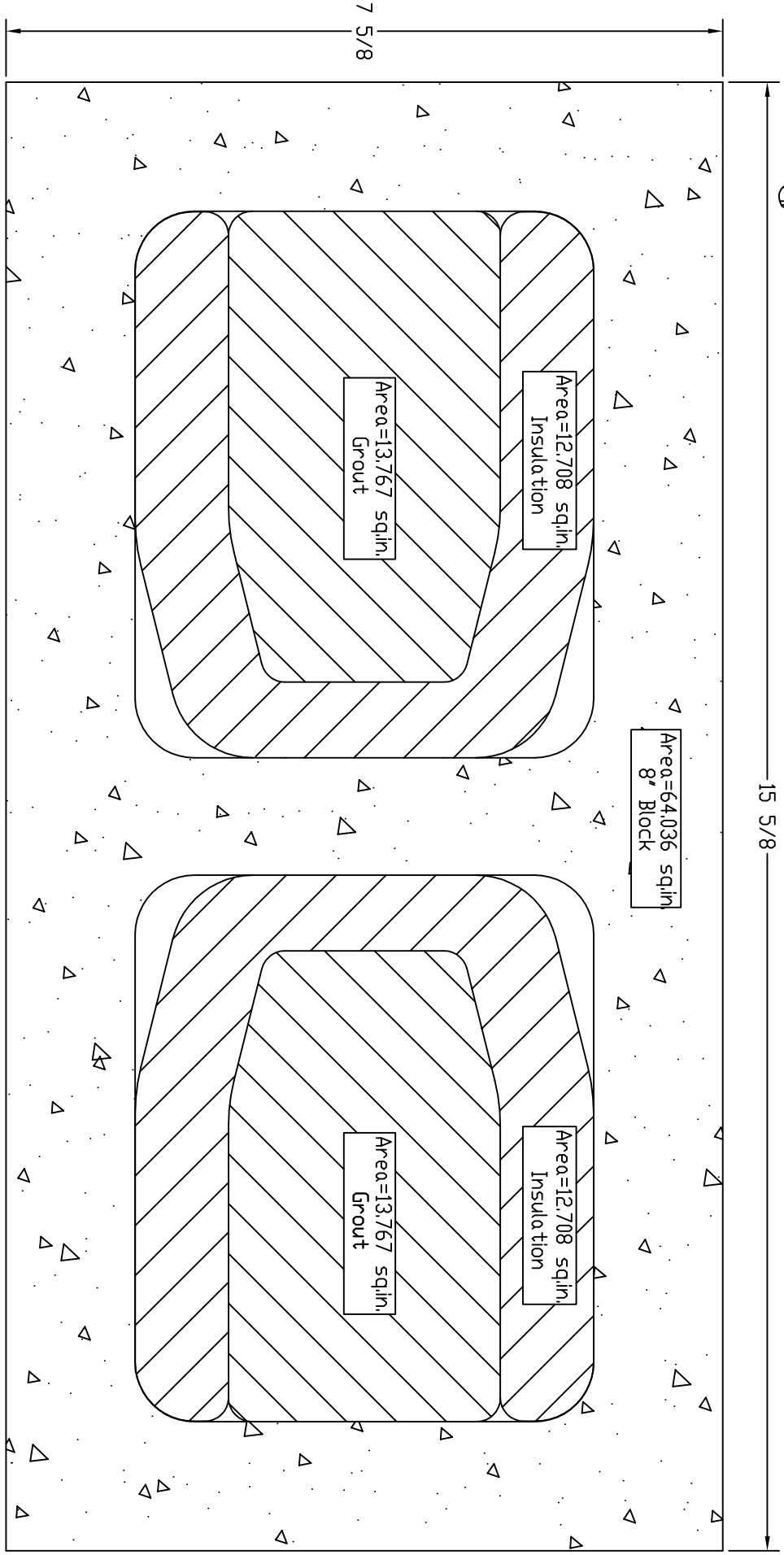
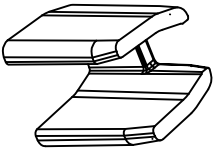

NOTE:

1. 8" Block Dimensions per NCMA Standards
2. View Shown at Half High Level
3. Korfil U-Shape Insulation Shown
4. Lower View Shown

CBIS/KORFIL
P.O. BOX 1000
FREIGHT HOUSE ROAD
WEST BROOKFIELD, MA. 01585
WWW.CBISINC.COM



GRYCEL
5/7/2010

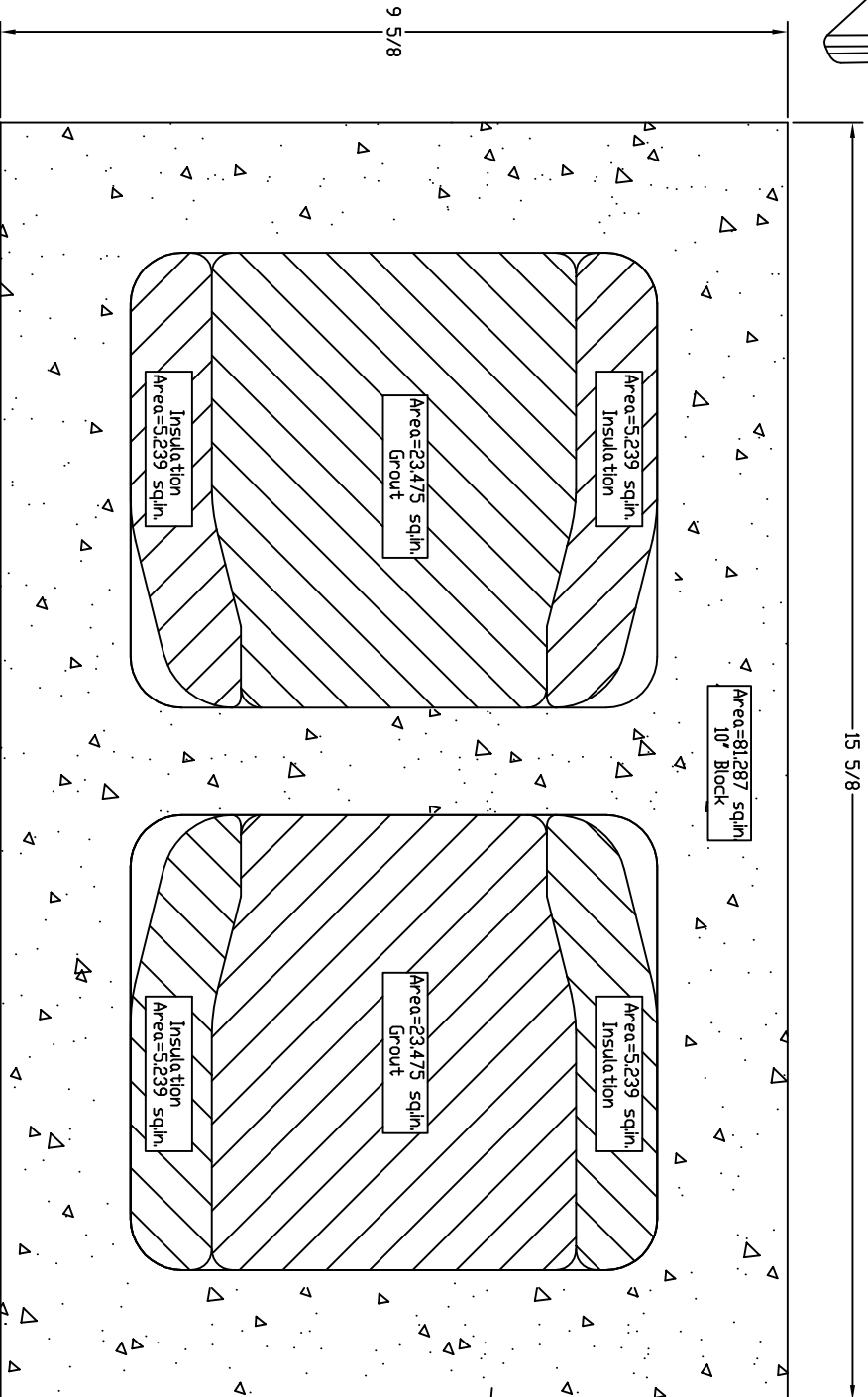
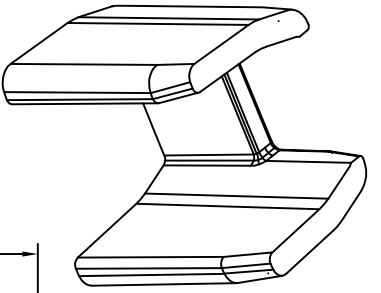

NOTE:

1. 10" Block Dimensions per NCMA Standards
2. View Shown at Half High Level
3. Korfil U-Shape Insulation Shown
4. Upper View Shown (The Void Section At The Center Web Is Where The Hand Hold Is Located)

CBIS/KORFIL

P.O. BOX 1000
FREIGHT HOUSE ROAD
WEST BROOKFIELD, MA. 01585
WWW.CBISINC.COM



GRYCEL
5/7/2010

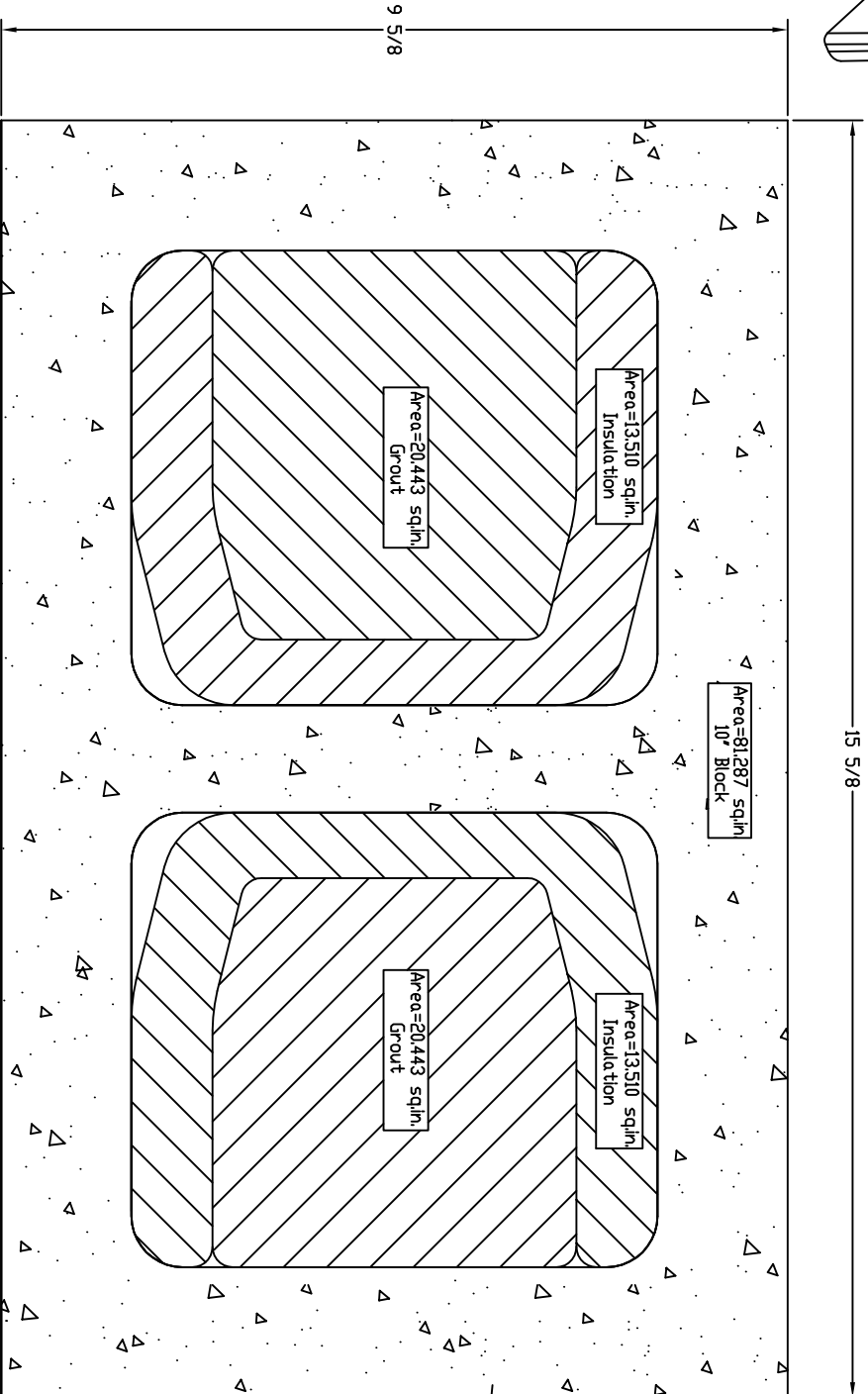
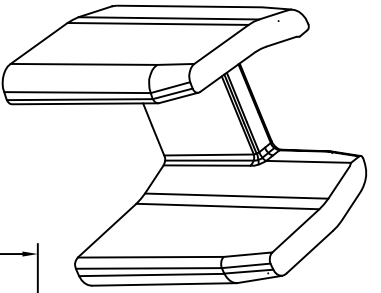

NOTE:

1. 10" Block Dimensions per NCMA Standards
2. View Shown at Half High Level
3. Korfil U-Shape Insulation Shown
4. Lower View Shown

CBIS/KORFIL

P.O. BOX 1000
FREIGHT HOUSE ROAD
WEST BROOKFIELD, MA. 01585
WWW.CBISINC.COM



GRYCEL

5/7/2010

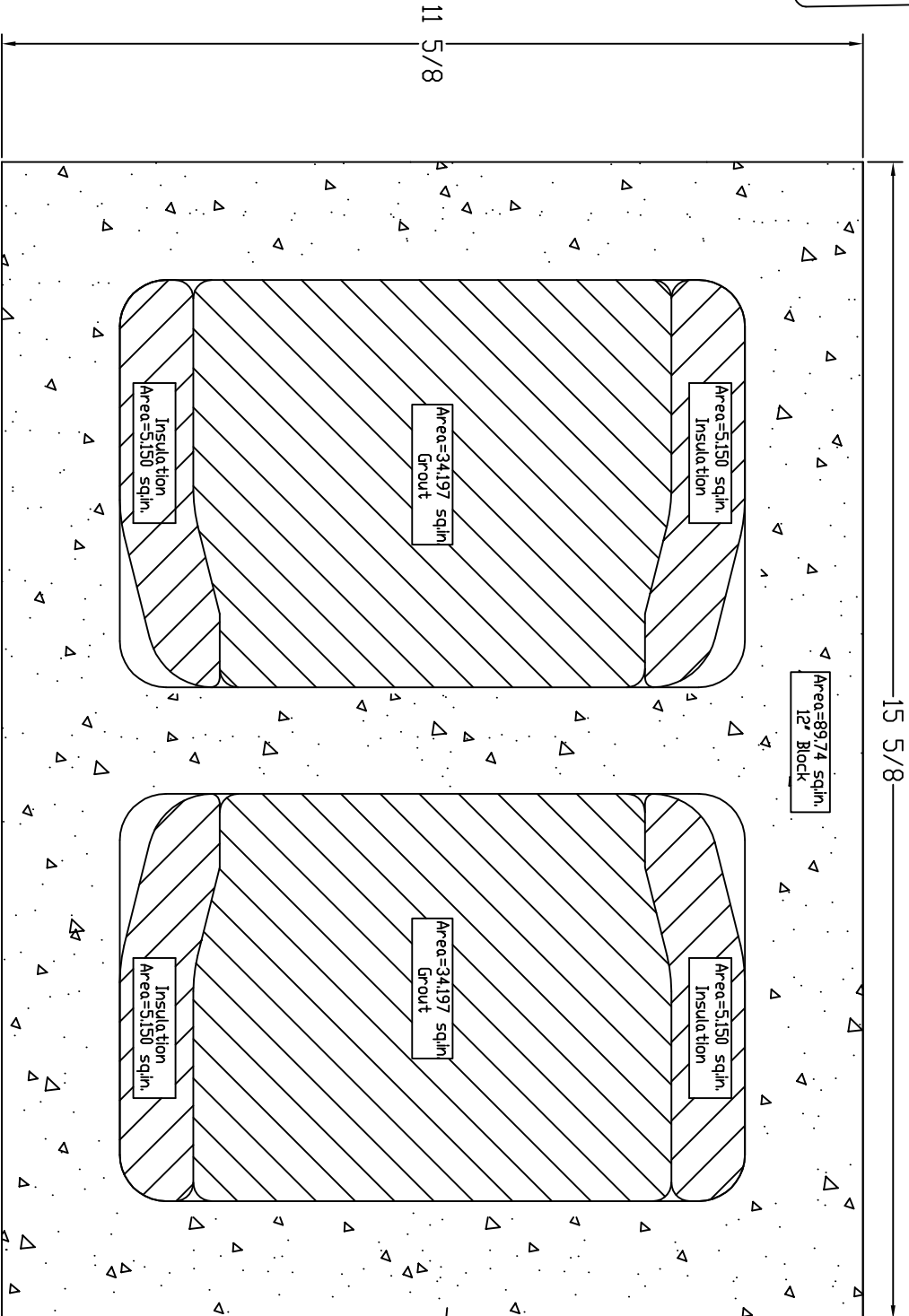
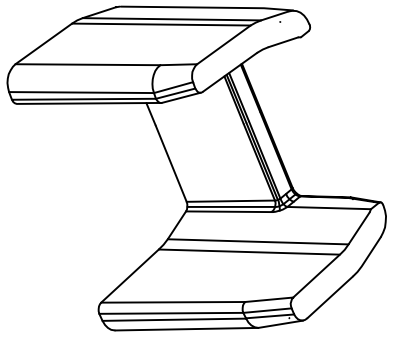

NOTE:

1. 12" Block Dimensions per NEMA Standards
2. View Shown at Half High Level
3. Korfil U—Shape Insulation Shown
4. Upper View Shown (The Void Section At The Center Web Is Where The Hand Hold Area Is Located)

CBIS/KORFIL

P.O. BOX 1000
 FREIGHT HOUSE ROAD
 WEST BROOKFIELD, MA. 01585
 WWW.CBISINC.COM

GRYCEL
 5/7/2010

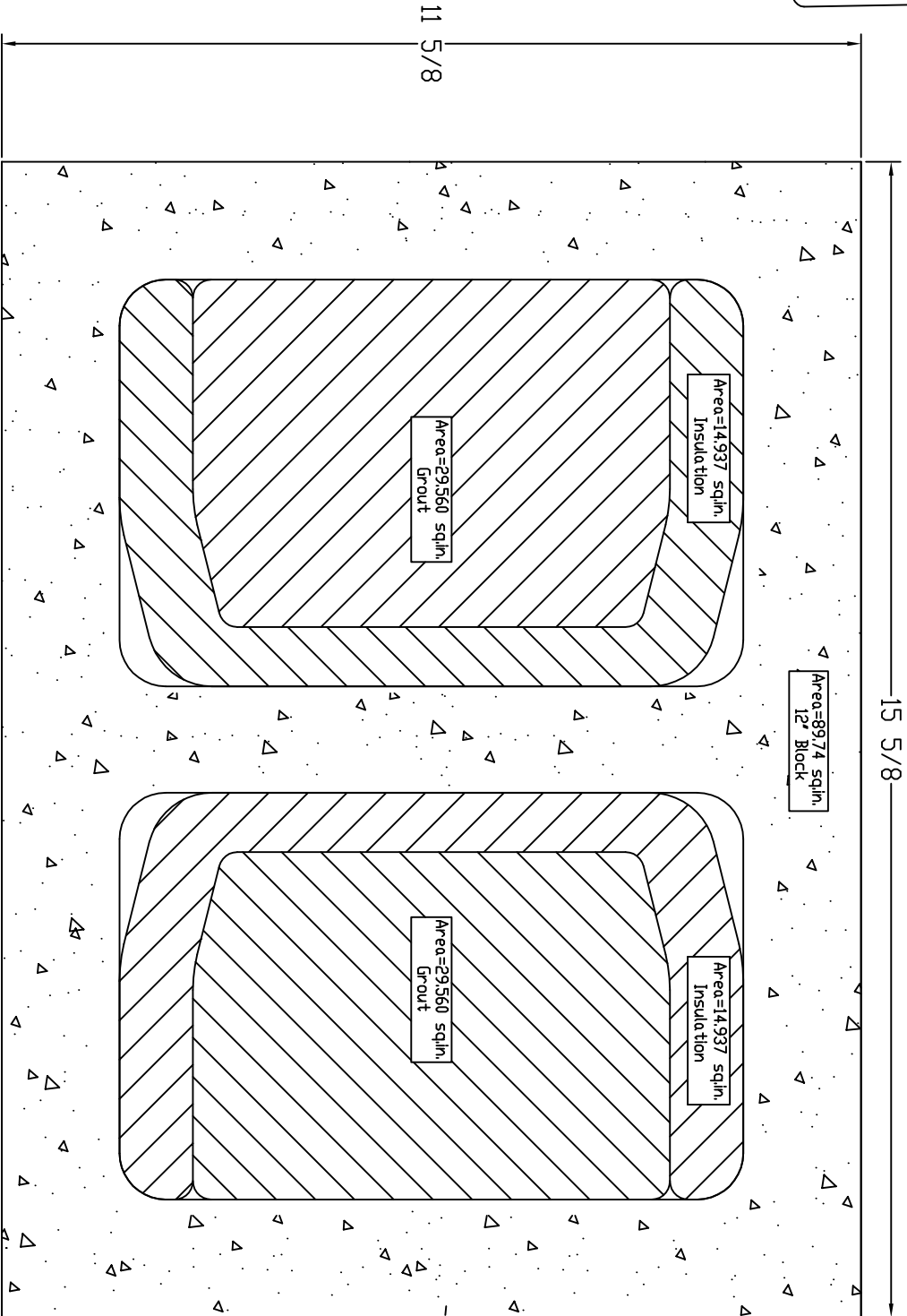
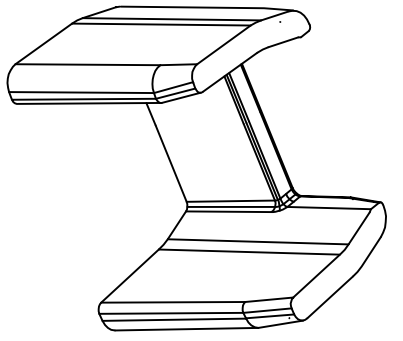

- NOTE:**
1. 12" Block Dimensions per NEMA Standards
 2. View Shown at Half High Level
 3. Korfil U—Shape Insulation Shown
 4. Lower View Shown

CBIS/KORFIL
 P.O. BOX 1000
 FREIGHT HOUSE ROAD
 WEST BROOKFIELD, MA. 01585
 WWW.CBISINC.COM



GRYCEL
 5/7/2010